

CLIPPERCREEK, INC.

INNOVATIVE INFRASTRUCTURE FOR  
ELECTRIC AND HYBRID VEHICLES

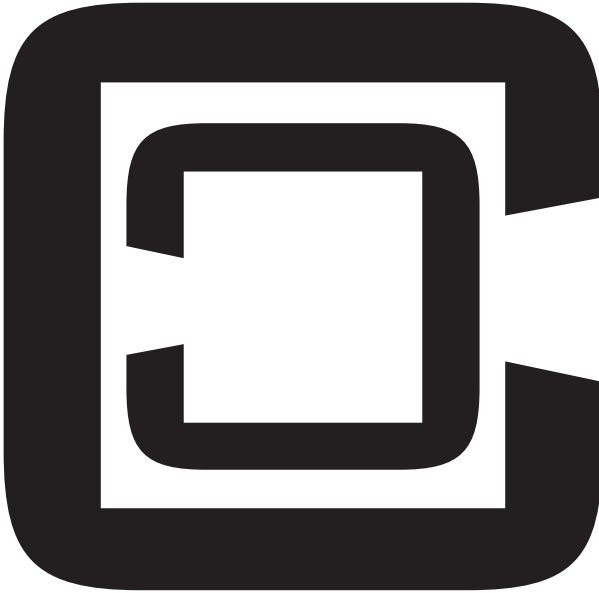

# User's Manual



Model LCS

With Isolation Monitor for 230VAC

## **PLEASE NOTE**

This user's manual includes the latest information at the time of printing. ClipperCreek, Inc. reserves the right to make changes to this product without further notice. Changes or modifications to this product by other than an authorized service facility may void the product warranty.

If you have questions about the use of this product, contact your customer service representative. Refer to the Customer Support section located in this guide.

**Please visit ClipperCreek's Website @ [www.clippercreek.com](http://www.clippercreek.com)**

# CONTENTS

IMPORTANT SAFETY INSTRUCTIONS .....	1
INSTRUCTIONS PERTAINING TO A RISK OF FIRE OR ELECTRIC SHOCK.....	1
SAFETY INFORMATION .....	2
FCC INFORMATION .....	2
OPERATION .....	3
FRONT PANEL .....	4
INSTALLATION .....	5
SERVICE CONNECTIONS.....	5
MOUNTING PROCEDURES .....	8
WIRING INSTRUCTIONS.....	9
SPECIFICATIONS .....	10
CUSTOMER SUPPORT.....	11
MAINTENANCE .....	11
WARRANTY INFORMATION .....	12

# IMPORTANT SAFETY INSTRUCTIONS

Carefully read these instructions and the charging instructions in your vehicle owner's handbook before charging your electric vehicle.

The following symbols may be found in this manual or on labels affixed to the charge station:

**NOTE**

*This means pay particular attention. Notes contain helpful suggestions.*



**CAUTION:** *This symbol means be careful. You are capable of doing something that might result in damage to the equipment.*



**WARNING:** *This symbol means danger. You are in a situation that could cause bodily injury. Before you work on any electrical equipment, be aware of the hazards involved with electrical circuitry and standard practices for preventing accidents.*

## Instructions Pertaining to a Risk of Fire or Electric Shock

When using the the LCS, basic electrical safety precautions should be followed:

- Use this charge station to charge electric vehicles equipped with an *SAE-J1772™* charge port only. See the vehicle's owner's handbook to determine if the vehicle is equipped with the correct charge port.
- Make certain the charge station's *SAE-J1772™* charge cable is positioned so it will not be stepped on, tripped over, or otherwise subjected to damage or stress.
- There are no user serviceable parts inside. Refer to the Customer Support section in this manual for service information. Do not attempt to repair or service the charge station yourself.
- Do not operate your charge station if it or the *SAE-J1772™* charge cable is physically open, cracked, frayed, or otherwise visibly damaged. Contact your Service Representative for service immediately. Refer to the Customer Support section in this manual for information on the Service Representative in your area.
- Do not place fingers inside of the coupler end of the *SAE-J1772™* charge cable.
- Do not allow children to operate ths device. Adult supervision is mandatory when children are in proximity to a charge station that is in use.



**SAVE THESE INSTRUCTIONS FOR FUTURE REFERENCE.**

## SAFETY INFORMATION



**WARNING:** Turn off input power to your charge station at the circuit breaker panel before servicing or cleaning the unit.

**NOTE** VENTILATION: Some electric vehicles require an external ventilation system to prevent the accumulation of hazardous or explosive gases when charging indoors. Check the vehicle's owner's handbook to determine if your vehicle requires ventilation during indoor charging.

**NOTE** Those vehicles which follow the *SAE-J1772™* standard for communication with the charging station can inform the LCS that they require an exhaust fan. The LCS is not equipped to control ventilation fans. Do not charge your vehicle with the LCS if ventilation is required by your vehicle.



**CAUTION: DO NOT** charge your vehicle indoors if it requires ventilation. Contact your Service Representative for information.

## FCC INFORMATION

This device complies with Part 15 of the FCC rules. Operation is subject to the following two conditions: (1) This device may not cause harmful interference, and (2) This device must accept any interference received, including interference that may cause undesired operation.

This product has been designed to protect against Radio Frequency Interference (RFI). However, there are some instances where high powered radio signals or nearby RF-producing equipment (such as digital phones, RF communications equipment, etc.) could affect operation.

If interference to your charge station is suspected, we suggest the following steps be taken before consulting your ClipperCreek Sales and Service Representative for assistance:

1. Reorient or relocate nearby electrical appliances or equipment during charging.
2. Turn off nearby electrical appliances or equipment during charging.



**CAUTION:** Changes or modifications to this product by other than an authorized service facility may void FCC compliance.

# OPERATION

The LCS Electric Vehicle Charging Station is a compact wall-mounted charging station that provides the Plug-in Hybrid or Battery Electric Vehicle (together Plug-In Electric Vehicles, or “PEV”) user with a safe and manageable link between the power grid and the PEV.

*Figure 1. Front Panel*



The LCS is very easy to use. Just unwrap the *SAE-J1772<sup>™</sup>* charge cable and plug the charge coupler firmly into the vehicle's charge port.

Normally, the vehicle will immediately request a charge using a special communication line in the cable. Within a few seconds the green “Charging” light on the face of the LCS will turn on and the charging cycle will begin. After an average driving day the vehicle battery pack will require several hours to recharge completely. Charging overnight is the most convenient way to maintain healthy batteries and ensure the vehicle's full range will be available for the next day.

When the vehicle has stopped charging the green “Charging” light on the LCS will turn off. To remove the charge coupler once a charge cycle has completed (or to interrupt a charge in progress) press and hold down the latch release lever on the charge coupler handle then unplug the charge coupler from the vehicle charge port.

## FRONT PANEL – Isolation (Insulation) Monitor

The front panel on the LCS has four indicator lights:

**Power** (yellow), indicates that power is available.

**Charging** (green), indicates that AC power is currently applied to the vehicle.

**Ground (Earth) Present** (amber), indicates the status of the LCS isolation monitor. Should there be less than approximately 50KOhms of measured resistance to ground (earth), the LED turns on. When the resistance to ground (earth) exceeds 50KOhms, this LED turns off. The LCS will charge the vehicle in either condition.

**Charging Fault** (red), indicates that the LCS is unable to communicate with the vehicle correctly.

*Table 1. Front panel LED information for an isolation monitor-equipped LCS*

#	Amber Power LED	Green Charging LED	Ambr Ground LED	Red Charging Fault LED	Fault Condition
1	off	off	off	off	No power to EVSE. Check circuit breaker.
2	ON	off	ON or off	off	Not plugged in to the EV or the EV is not ready to charge.
3	ON	ON	ON or off	off	Charging enabled, power is applied to the vehicle.
4	ON	ON or off	ON - not blinking	off	Isolation monitor detects low resistance to ground.
5	ON	ON or off	off	off	Isolation monitor detects high resistance to ground.
6	ON	off	ON or off	ON - not blinking	*Problem with EV communications. Disconnect and restart.
7	ON	off	ON or off	blinking	*EV ground fault trip. Check vehicle connection.
8	ON	off	blinking	blinking	*Internal EVSE fault. Call for service.

# INSTALLATION

## SERVICE CONNECTIONS



**CAUTION:** To reduce the risk of fire, connect only to a circuit provided with the appropriate maximum branch circuit overcurrent protection in accordance with local electrical codes.

For a Model LCS-15, use a 15A circuit breaker.

For a Model LCS-20, use a 20A circuit breaker.

For a Model LCS-25, use a 25A circuit breaker.

For a Model LCS-30, use a 30A circuit breaker.



**CAUTION:** This is a single-phase device. Do not connect more than one phase of a 3-phase feed !!! You may use any one phase of a three-phase wye-connected feed.



**CAUTION:** The phase used must measure approximately 230V AC to Neutral. Protective Earth must be connected to Neutral at one or more points in the system.



**CAUTION:** Warranty is void if this unit is wired improperly.



**WARNING:** Only a qualified electrician should perform the installation. The installation must be performed in accordance with all local electrical codes and ordinances.

Neutral must be connected to Protective Earth somewhere in the system for any of the three earthing system arrangements. Ground (earth) fault protection is not possible unless the Neutral is connected to Protective Earth.



The following diagrams illustrate three earthing systems for the 230VAC TN network power grid with which the LCS is compatible. These three earthing systems are described as follows:

**TN-S:** Separate Neutral and Protective Earth conductors are connected only at the service panel or other primary electrical distribution point. Each conductor is separately routed and wired to the corresponding Neutral and Protective Earth conductors on the LCS.

*Figure 2. 230V Single Phase TN-S Earthing System*

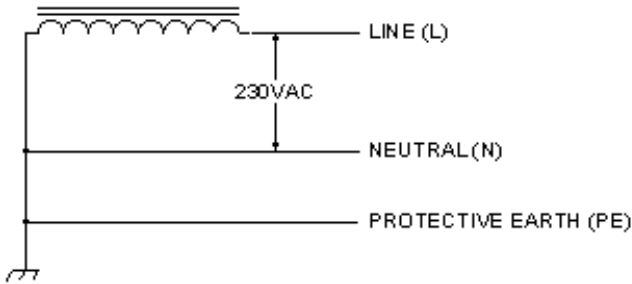

**TN-C:** A combined Protective Earth and Neutral conductor (PEN) is run from the primary electrical distribution point to the LCS. The Neutral and Protective Earth conductors must be separated at this point in order to connect to the corresponding Neutral and Protective Earth conductors provided with the LCS.

*Figure 3. 230V Single Phase TN-C Earthing System*

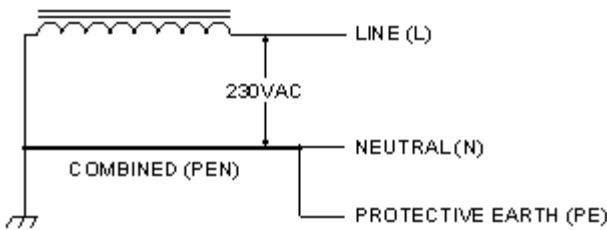

**TN-C-S:** In this hybrid system, a combined PEN conductor is separated into Neutral and Protective Earth conductors for distribution throughout a building. These separated conductors connect to the corresponding Neutral and Protective Earth conductors on the LCS.

*Figure 4. 230V Single Phase TN-C-S Earthing System*

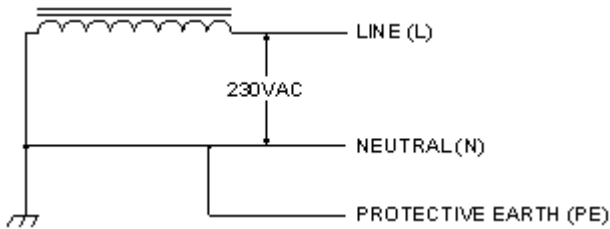

# MOUNTING PROCEDURES

Locate the wall mounting position of the EVSE:

- The three LCS service conductors are shielded by a 3 foot (0.9m) flexible conduit. The LCS must be positioned such that this conduit can reach a nearby service panel or junction box.
- Position the bottom of the charge station at a comfortable height and at least 18 inches (0.45m) above the ground. Ensure that the LEDs on the front panel of the EVSE can clearly be seen by anyone who will be operating the device.
- The LCS has four mounting holes spaced in a 2" (50.8mm) wide by 10" (254mm) tall rectangular pattern. Use a template to mark hole locations on the wall.

## For Hollow-Wall Construction:

- Place the unit such that at least two (but preferably all four) mounting holes can take advantage of solid structural framing inside of the wall or a strong wall surface such as plywood.
- For any remaining mounting holes which do not have a solid mounting structure (such as drywall without a solid backing) it will be necessary to use proper anchoring hardware such as drywall toggles or molly bolts.

## For Solid-Wall Construction:

- To secure the unit in concrete, pre-drill appropriately sized holes and use multi-set or wedge anchor hardware at all four mounting points.
- To secure the unit in brick or stone, pre-drill appropriately sized holes and use sleeve anchors at all four mounting points.

*Figure 5. Mounting the LCS to a hollow wall*

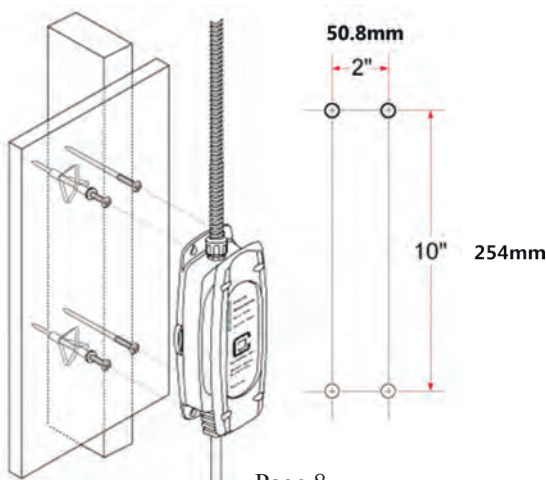

Machine screw size #10 (or M5 metric) hardware is recommended for mounting the LCS. Screw shafts of at least 2" (5cm) are recommended. The LCS mounting holes are 3/8" (9.5mm) in diameter, so ensure that the screw heads do not exceed this size. Place appropriately sized washers between the screw heads and the LCS enclosure mounting flanges.

## WIRING INSTRUCTIONS

Route the LCS conduit to a nearby service panel or junction box. Use the included 1/4" trade size watertight fitting to provide a moisture-resistant seal with the service panel or junction box. If necessary, drill a 1/2" diameter hole to accommodate the liquid-tight fitting or use the included 1/4" NP to 1/2" NPT thread reducer kit.

*Figure 6. Wiring the LCS in a junction box*

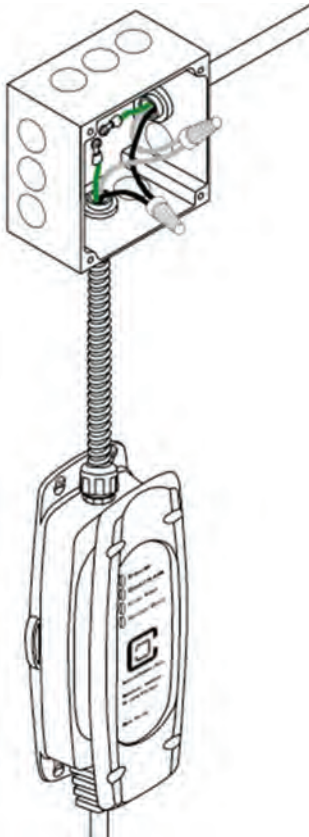

**NOTE**

Before connecting the LCS service conductors, please carefully read the section of this manual titled Service Connections, on page 9. If you are unsure of the type of power provided at the service panel, please consult with your local utility or call your Service Representative for assistance.

**NOTE**

The three LCS service conductors use stranded 12AWG, 75°C copper wire. The insulation of each conductor is color coded as follows:

Green:	Protective Earth
Black:	Line - 230VAC
White:	Neutral

# SPECIFICATIONS

<b>Line Input Power Voltage &amp; Wiring</b>	230V AC single-phase - Line, Neutral, and Protective Earth. This product is designed for use on the 230VAC TN-S, TN-C, and TN-C-S earthing systems.		
<b>Service Conductors</b>	Line, Neutral, and Protective Earth use 12AWG, 75°C copper wire.		
<b>Voltage Range</b>	185V AC to 264V AC		
<b>Frequency</b>	50 Hz		
<b>Current</b>	<u>LCS-Model</u>	<u>Circuit Breaker</u>	<u>Maximum Current</u>
	LCS-15	15A	12A
	LCS-20	20A	16A
	LCS-25	25A	20A
	LCS-30	30A	24A
<b>Output Power</b>	Note that the maximum current for the vehicle is set by the duty cycle of the Pilot waveform. Variable depending upon the LCS model and vehicle demand. At 230V AC, the LCS-15 outputs approximately 2.9KW, the LCS-20 3.8KW, LCS-25 4.8KW, and the LCS-30 5.5KW.		
<b>Dimensions</b>	Dimensions are for the enclosure only.		
<b>Height</b>	280 mm (11 in)		
<b>Width</b>	100 mm (4 in)		
<b>Depth</b>	80 mm (3 in)		
<b>Weight</b>	2.7kg (6lbs) with SAE-J1772™ connector and 20' cable		
<b>Environment</b>	<b>Operating Temperature</b>	30°C (-22°F) to +50°C (+122°F)	
	<b>Enclosure Rating</b>	NEMA 4X - watertight	
<b>Agency Approvals</b>	FCC Part 15 Class B		

## CUSTOMER SUPPORT

Call your ClipperCreek, Inc. Service Representative at any time, 24 hours a day, at the number below. **PLEASE HAVE THE MODEL NUMBER AND SERIAL NUMBER AVAILABLE WHEN YOU CALL.** This information is printed on the label on the back side of the LCS enclosure. If your call is made after business hours or on weekends, please leave your name, telephone number, the unit serial number, and a brief description of the problem. A Service Representative will call back at the earliest opportunity.

**Distributor Service  
Number Here**

## MAINTENANCE

The LCS requires no periodic maintenance other than occasional cleaning.



**WARNING:** To reduce the risk of electrical shock or equipment damage, exercise caution while cleaning the unit and the EV charge connector cable.

1. Turn off the charge station at the circuit breaker before cleaning.
2. Clean the charge station using a soft cloth lightly moistened with mild detergent solution. Never use any type of abrasive pad, scouring powder, or flammable solvents such as alcohol or benzene.

# WARRANTY INFORMATION

## LIMITED WARRANTY ELECTRIC VEHICLE SUPPLY EQUIPMENT and ACCESSORIES

ClipperCreek, Inc.  
11850 Kemper Road Auburn, California 95603  
Phone: 877-694-4194 Email: information@clippercreek.net

ClipperCreek shall provide the following warranty with respect to the Products to Representative, its Sub-Representatives and their customers:

### **Product 3-year parts, 3-year factory labor:**

ClipperCreek, Inc. warrants this product to be free from defects in material and workmanship. The warranty period shall commence on the date of installation date (first use). The product installation date must be evidenced and communicated to ClipperCreek by way of the warranty registration card (or its equivalent). The warranty registration card must be filled out completely and accurately, and returned to ClipperCreek within 30 days after installation, and the product installation date shall be within 6 months after the purchase date. If a Product installation date is not communicated to ClipperCreek as described above, the product purchase date shall serve as the warranty commencement date.

If this product is defective in materials or workmanship during the warranty period, ClipperCreek will, at its option, repair or replace the product. Repair parts and/or replacement products may be either new or reconditioned at ClipperCreek's discretion. This limited warranty does not cover service or parts to repair damage due to improper installation or use, including but not limited to improper connections with peripherals, external electrical faults, accident, disaster, misuse, abuse or modifications to the product not approved in writing by ClipperCreek. Any service repair outside the scope of this limited warranty shall be at applicable rates and terms then in effect. This warranty covers factory parts and factory labor only; it does not cover field service or removal and replacement of the product or any other costs.

All other express and implied warranties for this product including the warranties of merchantability and fitness for a particular purpose are hereby disclaimed. Some states do not allow the exclusion of implied warranties or limitations on how long an implied warranty lasts, so the above limitation may not apply to you. If this product is not as warranted above, your sole and exclusive remedy shall be repair or replacement as provided above. In no event will ClipperCreek, any of its authorized sales and service representatives, or its parent company be liable to customer or any third party for any damages in excess of the purchase price of the product. This limitation applies to damages of any kind including any direct or indirect damages, lost profits, lost saving or other special, incidental, exemplary or consequential damages whether for breach of contract, tort or otherwise or whether arising out of the use of or inability to use the product, even if ClipperCreek or an authorized ClipperCreek representative or dealer has been advised of the possibility of such damages or of any claim by any other party. Some states do not allow the exclusion or limitation of incidental damages for some products, so the above limitation or exclusion may not apply to you. This warranty gives you specific legal rights, and you may also have other rights which may vary from state to state.

### **To obtain warranty service:**

Call your nearest authorized Service Representative or ClipperCreek at the above number. You will receive information as to how service for the product will be provided. If you mail or ship the product in for service, you must insure the product, prepay all shipping charges, and properly pack it for shipment in its original shipping container or its equivalent. You are responsible for all loss or damage that may occur in transit. You must provide proof of purchase of the product and the purchase date before any warranty service can be performed.

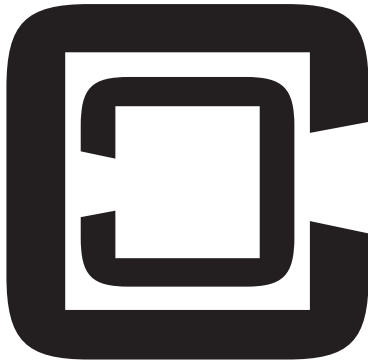

CLIPPERCREEK, INC.  
11850 KEMPER RD., SUITE E  
AUBURN, CA 95603  
[WWW.CLIPPERCREEK.COM](http://WWW.CLIPPERCREEK.COM)